

TRAVA T2900

(TRAVA MEET I-05 -TOP H95)

DISTRIBUTION

CONTRACT general

DESIGN

Vincent Dejonghe

LABEL

MOBITEC labelled product

TYPE

Meeting table, total height 95cm.



TABLETOP

Top in MDF 30mm with a 0.9mm in FENIX NTM® layer veneer.

The beveled edge, as well as the underside of the table top are lacquered in a color matching the color of the Fenix decor.

EXTENSION(S)

This version is always without extension.

FEET

Depending on the size of the table there are 2 types of feet.

Regardless of their position, feet are always in solid oak and equipped with adjustable WAGNER® glides.

Metal frame in steel wire Ø12 mm. The color of this metal structure is at your choice, among our range of metal colors.

SPECIAL FEATURES

For technical reasons, the table top can be supplied in several parts to fixed together.

Depending on the size, the top can be made up of 2, 4 or even 6 different parts.

When a table top is made up of several parts, these are screwed together from underneath the table to form the complete tray.

SECURITY

Our tables are heavy and require two people to assemble or move them.

DIMENSIONS (CM)

100x140 - 100x180 - 100x220 - 100x260 - 100x300 - 100x380 - 100x455 - 100x530 - 100x605 - 100x680 - 100x755cm

TRAVA T2900

WHICH SIZE?

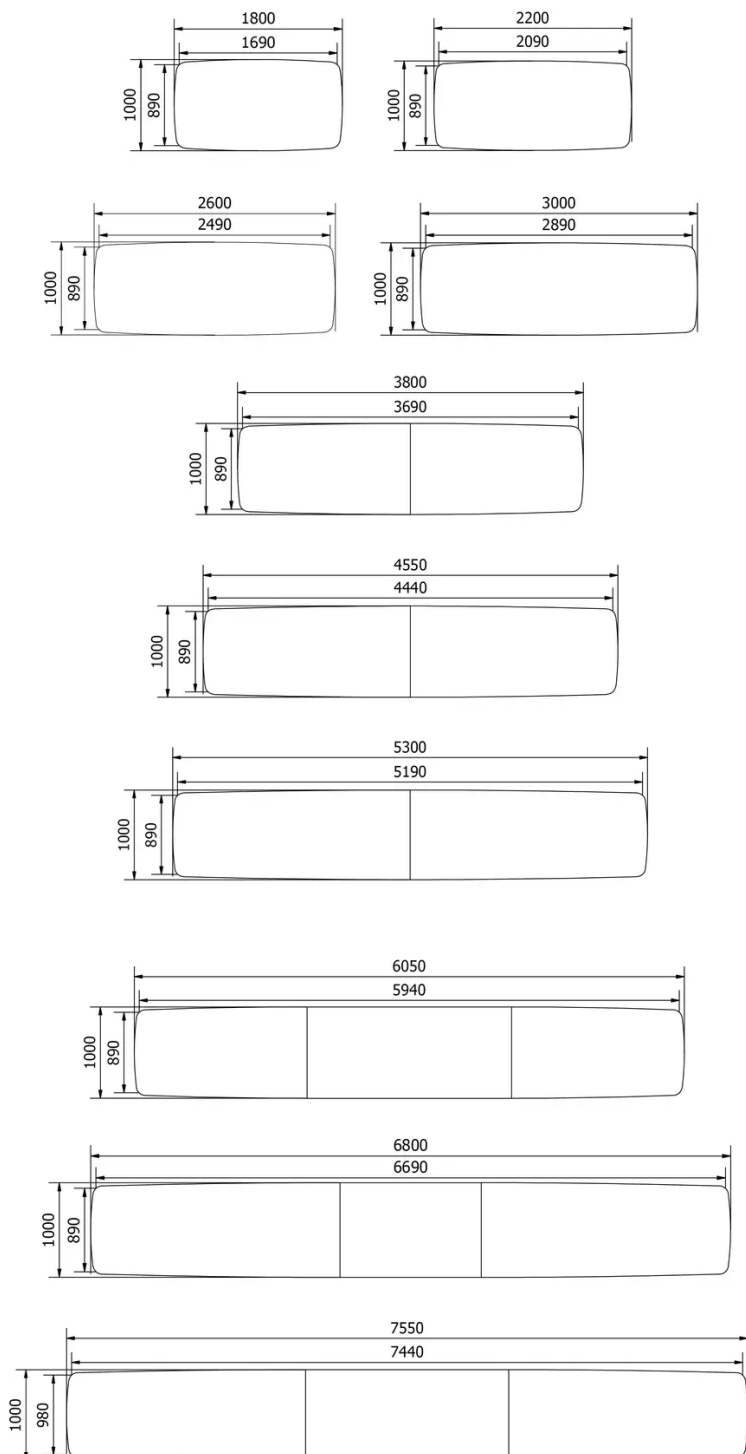

WEIGHT & PACKAGING

Packaging information available on request:

✉ info@mobitec.be

☎ +32 87 59 69 69