

ECLIPSE T0400

(ECLIPSE M-09 PB1 -EXT)

DISTRIBUTION

RETAIL X'clusive collection

DESIGN

Vincent Dejonghe

LABEL

MOBITEC labelled product

TYPE

dining room table, total height 76cm



TABLETOP

24mm multiplex base, black beveled edge, top veneer 0.6mm in «MOSAIC» oak / walnut.

Available in the woods and stains oak (E) and walnut (N).

EXTENSION(S)

This version is always without extension

FEET

Solid wood feet, you need to choose the colour of the metal part of the foot

SPECIAL FEATURES

-

SECURITY

Our tables are heavy and require two people to assemble or move them.

DIMENSIONS (CM)

ø110cm - ø135cm

100x180cm - 100x200cm - 110x220cm - 110x240cm - 120x260cm

ECLIPSE T0400

WHICH SIZE?

ECLIPSE Ø110cm

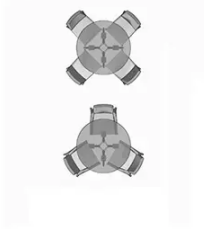

ECLIPSE Ø135cm

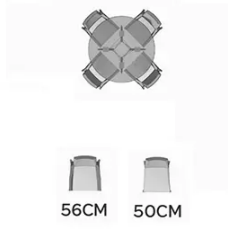

ECLIPSE 100X180cm

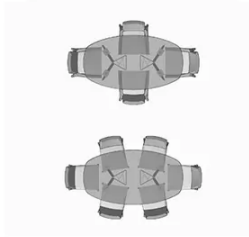

ECLIPSE 100X200cm



ECLIPSE 110X220cm

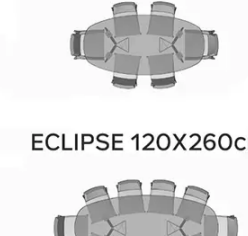

ECLIPSE 110X240cm

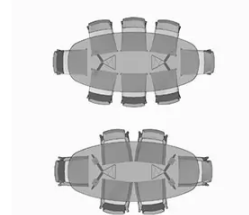

ECLIPSE 120X260cm

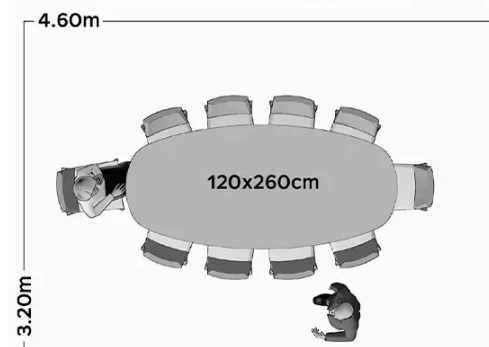
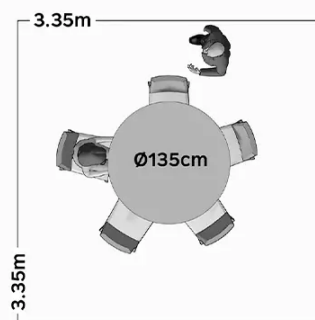
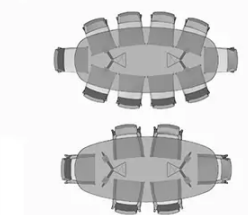

WEIGHT & PACKAGING

Dimensions: RD 135 cm

Number of boxes: 2

Grossweight: 63 kg

Packing volume: 0,58 m³

Dimensions: RD 110 cm

Number of boxes: 2

Grossweight: 44 kg

Packing volume: 0,42 m³

Dimensions: OV 120X260 cm

Number of boxes: 2

Grossweight: 66 kg

Packing volume: 0,30 m³

Dimensions: OV 110X240 cm

Number of boxes: 2

Grossweight: 58 kg

Packing volume: 0,26 m³

Dimensions: OV 110X220 cm

Number of boxes: 2

Grossweight: 55 kg

Packing volume: 0,24 m³

Dimensions: OV 100X200 cm

Number of boxes: 2

Grossweight: 48 kg

Packing volume: 0,21 m³

Dimensions: OV 100X180 cm

Number of boxes: 2

Grossweight: 44 kg

Packing volume: 0,19 m³